

KENWOOD

DIGITAL AV CONTROL AMPLIFIER / TUNER

KC-X1

INSTRUCTION MANUAL

KENWOOD CORPORATION

Introduction

Your choice of this product indicates that you are a devotee to excellence in sound reproduction.

We appreciate your patronage and take pride in the long tradition of quality components that our company represents.

So that you can get the most out of your unit, we suggest that you take the time to read through this manual before you hook up and operate your system. This will acquaint you with operating features and system-connection considerations so that your listening pleasure will be enhanced right from the start. You will notice that in all aspects of planning, engineering, styling, operating convenience and adaptability we have sought to anticipate your needs and desires.

Keep this manual handy for future reference.

For your records

Record the serial number, found on the back of the unit, in the spaces designated on the warranty card, and in the space provided below. Refer to the model and serial numbers whenever you call upon your dealer for information or service on this product.

Model _____ Serial Number _____

Unpacking

Unpack the unit carefully and make sure that all accessories are put aside so they will not be lost.

Examine the unit for any possibility of shipping damage. If your unit is damaged or fails to operate, notify your dealer immediately. If your unit was shipped to you directly, notify the shipping company without delay. Only the consignee (the person or company receiving the unit) can file a claim against the carrier for shipping damage.

We recommend that you retain the original carton and packing materials for use should you transport or ship the unit in the future.

Accessories

FM indoor antenna 1 AM loop antenna 1

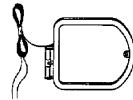

75Ω/300Ω antenna adaptor 1

Loop antenna stand 1



Batteries ("R03" or "AAA") 2

Remote control unit 1

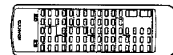





Overlay sheet 1

Audio cord 3



Contents

Caution : Read the pages marked  carefully to ensure safe operation.

| | | | |
|---|----|--|----|
| Introduction | 2 | Receiving a preset station | 25 |
|  Before applying power | 3 | Listening to all preset stations in sequence (PRESET CALL) | 25 |
|  Safety precautions | 3 | Direct tuning of radio stations | 25 |
|  IMPORTANT SAFEGUARDS | 4 | Operation with video components | 26 |
| About your new KENWOOD KC-X1 | 6 | Playback of videotape | 26 |
| Speaker layout | 9 | Recording of video source | 26 |
| System connections | 10 | Presence effect | 27 |
| Connection in case the KC-X1 is combined with KENWOOD KM-X1 power amplifier | 10 | THX CINEMA | 28 |
| Connection in case the KC-X1 is combined with other power amplifier than KENWOOD KM-X1 | 11 | THX CINEMA adjustment | 28 |
| Connection of video components | 13 | THX CINEMA playback | 29 |
| Connection for system control operation | 14 | DOLBY PRO LOGIC SURROUND | 30 |
| Controls and indicators | 15 | DOLBY PRO LOGIC adjustment | 30 |
| Operation of remote control unit | 16 | DOLBY PRO LOGIC playback | 31 |
| Programming functions from other remote control units ... | 18 | DOLBY 3 STEREO | 32 |
| To erase all of the programmed contents | 19 | Dolby 3 STEREO adjustment | 32 |
| Operating instructions | 20 | Dolby 3 STEREO playback | 32 |
| Basic operation | 20 | DSP LOGIC | 33 |
| To mute the sound temporarily | 22 | DSP LOGIC playback | 33 |
| Listening through headphones | 22 | MONO mode playback | 33 |
| Ordinary tape recording | 23 | Information display on TV monitor screen | 34 |
| Dubbing from TAPE2 to TAPE1 | 23 | Switching the information display | 34 |
| Receiving broadcast stations and storing them in memory (preset operation) | 24 | In case of difficulty | 36 |
| | |  SPECIFICATIONS | 38 |

Before applying power

 **Caution:** Read this page carefully to ensure safe operation.

For the U.S.A. and Canada

Important!

Units shipped to the U.S.A. and Canada are designed for operation on 120 volts AC only.

CAUTION: TO PREVENT ELECTRIC SHOCK DO NOT USE THE AC PLUG WITH AN EXTENSION CORD, RECEPTACLE OR OTHER OUTLET UNLESS THE BLADES CAN BE FULLY INSERTED TO PREVENT BLADE EXPOSURE.

For the United Kingdom

Important!

Units shipped to the U.K. are designed for operation on 240 volts AC only.

The mains plug must be removed from the wall socket prior to any internal examination.

The wires in this mains lead are coloured in accordance with the following code:

Blue Neutral
Brown Live

The wires in this mains lead must be connected to the terminals in the plug as follows:

| Wire colour | Plug terminal marking |
|-------------|-----------------------|
| Blue | N or Black |
| Brown | L or Red |

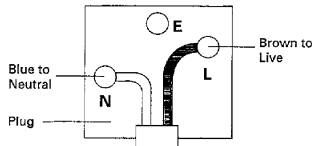

Notes:

1. If a 13-amp plug is used, this must be fitted with a 13-amp fuse.
2. If a 3-pin plug with earthing contact is used, no wire must be connected to the E terminal.

For Australia and Europe

Important!

Units shipped to Australia are designed for operation on 240 V AC only.

Units shipped to Europe are designed for operation on 230 V AC only.

For other countries

Important!

Units shipped to countries other than the above countries are equipped with an AC voltage selector switch on the rear panel. Refer to the following paragraph for the proper setting of this switch.

AC voltage selection

This unit operates on 110 - 120 or 220 - 240 volts AC. The AC voltage selector switch Type A or Type B on the rear panel is set to the voltage that prevails in the area to which the unit is shipped. Before connecting the power cord to your AC outlet, make sure that the setting position of this switch matches your line voltage. If not, it must be set to your voltage in accordance with the following direction.

AC voltage selector switch

Type A



Type B

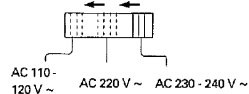

Move switch lever to match your line voltage with a small screwdriver or other pointed tool.

Note:

Our warranty does not cover damage caused by excessive line voltage due to improper setting of the AC voltage selector switch.

Safety precautions

WARNING: TO PREVENT FIRE OR ELECTRIC SHOCK, DO NOT EXPOSE THIS APPLIANCE TO RAIN OR MOISTURE.



CAUTION
RISK OF ELECTRIC SHOCK
DO NOT OPEN



CAUTION: TO REDUCE THE RISK OF ELECTRIC SHOCK, DO NOT REMOVE COVER (OR BACK). NO USER-SERVICEABLE PARTS INSIDE. REFER SERVICING TO QUALIFIED SERVICE PERSONNEL.



THE LIGHTNING FLASH WITH ARROWHEAD SYMBOL, WITHIN AN EQUILATERAL TRIANGLE, IS INTENDED TO ALERT THE USER TO THE PRESENCE OF UNINSULATED "DANGEROUS VOLTAGE" WITHIN THE PRODUCT'S ENCLOSURE THAT MAY BE OF SUFFICIENT MAGNITUDE TO CONSTITUTE A RISK OF ELECTRIC SHOCK TO PERSONS.



THE EXCLAMATION POINT WITHIN AN EQUILATERAL TRIANGLE IS INTENDED TO ALERT THE USER TO THE PRESENCE OF IMPORTANT OPERATING AND MAINTENANCE (SERVICING) INSTRUCTIONS IN THE LITERATURE ACCOMPANYING THE APPLIANCE.

IMPORTANT SAFEGUARDS

 **Caution:** Read this page carefully to ensure safe operation.

Please read all of the safety and operating instructions before operating this unit. For best results, follow all warnings placed on the unit and adhere to the operating and use instructions. These safety and operating instructions should be retained for future reference.

1. Power sources – The unit should be connected to a power supply only of the type described in the operating instructions or as marked on the appliance.

2. Power-cord protection – Power-supply cords should be routed so that they are not likely to be walked on or pinched by items placed upon or against them, pay particular attention to cords at plugs, convenience receptacles, and the point where they exit from the unit.

Never pull or stretch the cord.



3. Grounding or polarization – The precautions should be taken so that the grounding or polarization means of this unit is not defeated.

4. Ventilation – The unit should be situated so that its location or position does not interfere with its proper ventilation.

To maintain good ventilation, do not put records or a table-cloth on the unit. Place the unit at least 10 cm away from the walls.

Do not use the unit on a bed, sofa, rug or similar surface that may block the ventilation openings.

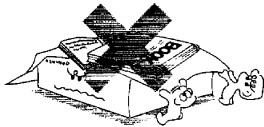

5. Water and moisture – The unit should not be used near water - for example, near a bathtub, washbowl, kitchen sink, laundry tub, in a wet basement, or near a swimming pool, etc.

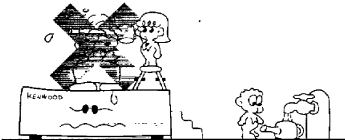

6. Temperature – The unit may not function properly if used at extremely low, or freezing temperatures. The ideal ambient temperature is above +5°C (41°F).

7. Heat – The unit should be situated away from heat sources such as radiators, heat registers, stoves, or other units (including amplifiers) that produce heat.

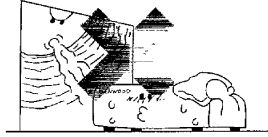

8. Electric shock – Care should be taken so that objects do not fall and liquid is not spilled into the enclosure through openings. If a metal object, such as a hair pin or a needle, comes into contact with the inside of this unit, a dangerous electric shock may result. For families with children, never permit children to put anything, especially metal, inside this unit.

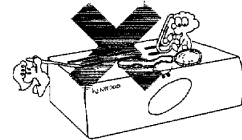

9. Enclosure removal – Never remove the enclosure. If the internal parts are touched accidentally, a serious electric shock might occur.

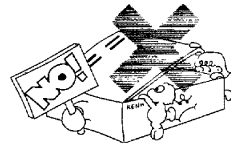

10. Magnetic fields – Keep the unit away from sources of magnetic fields such as TV sets, speaker systems, radios, motorized toys or magnetized objects.

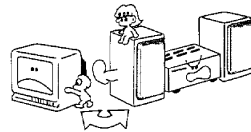

11. Cleaning – Do not use volatile solvents such as alcohol, paint thinner, gasoline, or benzine, etc. to clean the cabinet. Use a clean dry cloth.

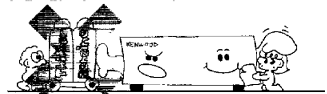

12. Carts and stands – An appliance and cart combination should be moved with care. Quick stops, excessive force, and uneven surfaces may cause the appliance and cart combination to overturn.



13. Nonuse periods – The power cord of the unit should be unplugged from the outlet when left unused for a long period of time.

14. Abnormal smell – If an abnormal smell or smoke is detected, immediately turn the power OFF and pull out the power cord. Contact your dealer or nearest service center.

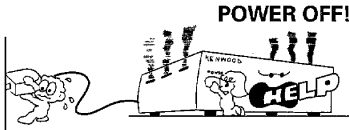

15. Damage requiring service – The unit should be serviced by qualified service personnel when:

- A. The power-supply cord or the plug has been damaged; or
- B. Objects have fallen, or liquid has been spilled into the unit; or
- C. The unit has been exposed to rain; or
- D. The unit does not appear to operate normally or exhibits a marked change in performance; or
- E. The unit has been dropped, or the enclosure damaged.

16. Servicing – The user should not attempt to service the unit beyond that described in the operating instructions. All other servicing should be referred to qualified service personnel.

17. Outdoor antenna grounding – If an outside antenna is connected to the receiver, be sure the antenna system is grounded so as to provide some protection against voltage surges and built up static charges. Section 810 of the National Electrical Code, ANSI/NFPA 70, provides information with respect to proper grounding of the mast and supporting structure, grounding of the lead-in wire to an antenna discharge unit, size of grounding conductors, location of antenna-discharge unit, connection to grounding electrodes, and requirements for the grounding electrode. See Figure.

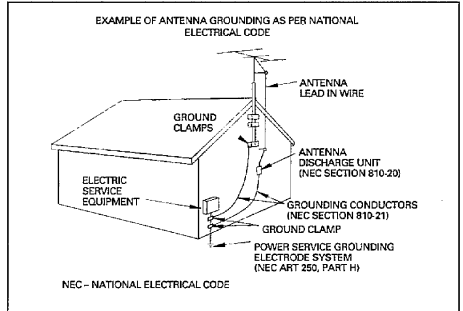

18. Power lines – An outdoor antenna should be located away from power lines.

19. AC outlets – Do not connect other audio equipment with a power consumption larger than that specified to the AC outlet on the rear panel. Never connect other electrical units, such as an iron or toaster, to it to prevent fire or electric shock.

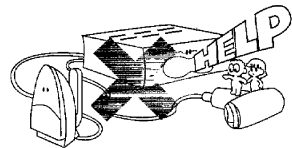

Notes:

1. Item 3 is not required except for grounded or polarized equipment.
2. Item 17 and 18 are not required except for units provided with antenna terminals.
3. Item 17 complies with UL in the U.S.A.

About your new KENWOOD KC-X1

The KC-X1 is not just a high-performance control amplifier and tuner, it is designed to serve as the nucleus of advanced home theater systems. In addition to unsurpassed sound quality, this hi-fidelity component incorporates leading-edge THX CINEMA, DOLBY PRO LOGIC and DOLBY 3 STEREO surround systems and Kenwood's original DSP LOGIC surround mode. Providing the flexibility to create the perfect sound field for virtually any video or music source. Enjoy the powerful, alive feeling of "being there."

Power Amplifier Requirements

To properly enjoy surround effects with video and music sources played through the KC-X1, the connected power amplifier must support from three to six channels, depending on the surround mode. For maximum surround enjoyment, Kenwood offers the KM-X1 six-channel power amplifier — the perfect complement to the KC-X1. The KM-X1's design provides both high power and uncompromising sound quality, and reproduces the KC-X1's high-grade dynamic sound with ease.

S-VIDEO

The KC-X1 is provided with S-VIDEO connectors for maintaining maximum picture quality and resolution when using S-VIDEO-equipped video components.

Full Array of Video Terminals

Four video channels are provided for connection of a full range of video equipment from VCRs and LD players to DBS (direct broadcast satellite) tuners. Internal switching circuitry allows dubbing between two VCRs or VCR recording of DBS broadcasts or laserdisc programs. Two composite video output channels and an S-VIDEO output channel are provided for connection to up to three TV monitors.

Receiver Function

No compromise has been made in the receiver section either. Incorporating a built-in digital tuner, quick station selection is possible using a 10-key number pad and a preset memory capable of memorizing up to 40 preset stations. Four audio input channels allow connection of a CD player, turntable and two tape decks in addition to the built-in tuner. When you wish to listen to the pure sound of the music source, a "TONE DEFEAT" function can be activated to bypass the tone control circuits.

Superior Design

The solid, simple styling emphasizes the excellent performance the KC-X1 is so comprehensively capable of. Despite its many features and functions, most operation controls are hidden behind an unobtrusive door, realizing an uncomplicated sophisticated design.

HOME THEATER CONCEPTS

DOLBY PRO-LOGIC

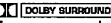
This is the same system used in movie theaters. Dolby Pro-Logic achieves the distinctive and powerful effects experienced in movie theaters not simply by expanding the spaciousness of the sound, but by decoding signals embedded in the video soundtrack to precisely and independently control the sounds emitted from the main front speakers and the surround speakers positioned to the rear of the listener. The resulting effect surrounds you in a sound field that draws you into the scene so completely you feel as if you are part of the action. Selecting this mode when playing video software bearing the  logo transforms your living room into a virtual movie theater. To use Dolby Pro-Logic, two rear speakers are needed in addition to the two front speakers. For maximum effect, add a center speaker and subwoofer to complete the system.

- You can enjoy Dolby Pro-Logic surround with or without a center speaker. (If your system has a center speaker, select WIDE BAND or NORMAL mode. If your system has no center speaker, select PHANTOM mode.)
- A center speaker of any size can be used. (If the center speaker is small, select NORMAL mode. If the center speaker is medium- or large-sized, select WIDE BAND mode.)
- Use of a center speaker improves the sound positioning of dialogue and expands the listening area obtained by the surround effect.
- Input balance is adjusted automatically.
- A built-in test tone generator is provided for calibrating the Dolby Pro-Logic system to your particular speaker setup and listening room characteristics.

DOLBY 3 STEREO

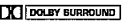
This system is effective when playing video software that does not bear the  logo, or when watching general TV broadcasts. If the audio is two-channel stereo and a large TV monitor or screen is positioned between the two front speakers, the dialogue which is supposed to come from the center (TV) position tends to be weak and ineffective. By selecting Dolby 3 Stereo, however, the system makes use of the center speaker in a three-channel configuration to emphasize the directionality of the sound and improve the positioning of the dialogue sound.

THX CINEMA

This is an improvement, with the theme of "A No - Compromise Home Cinema Experience", of the Dolby Pro Logic reproduction system to make it suitable for smaller spaces. In this mode, video software carrying  mark can be played. The already-proven effect of Dolby Pro Logic is complemented by an additional signal processor circuitry based on an original theory of THX CINEMA, and they are reproduced through the THX CINEMA's exclusive speaker system (approved by Lucas Arts Entertainment Company) composed of 6 speakers with excellent characteristics.

The THX CINEMA mode allows to enjoy an overwhelming feeling of presence.

DSP LOGIC

This mode is effective when playing music or a general video source. Digital signal processing is used to generate the "initial sound reflections" and "residual reverberations" that combine to create the atmosphere of a movie theater or concert hall.

MONO

Use this mode when watching old movies, etc., that have a monaural audio sound track.

The audio is heard from the center speaker only. If your system is not equipped with a center speaker, the monaural sound is reproduced from the front left and right speakers.

HOME THEATER CONCEPTS

STEREO TELEVISION

A stereo television receiver or video monitor is a necessity for enjoying programs containing stereo sound. Your choice can be either a direct view or a rear projection model, with cost and size being the only limits. A stereo television decodes the MTS (Multichannel Television Signal) that is part of the transmission signal to create left and right channels. Also, a number of prime-time shows, sports events, late-night shows and premium cable channels deliver their programs in the Dolby Surround format via the MTS signal. Refer to the "Connection to video components" section to learn how to hook up your set to the KC-X1 for surround sound decoding.

VCRS AND LASERDISC PLAYERS

For optimum performance, your VCR and/or laserdisc player should be able to reproduce two-channel stereo over a wide dynamic range. Video laserdisc players certainly meet this criteria, and Kenwood makes two laserdisc players — the LVD-700 and LVD-300 — that provide over 90 dB of dynamic range. Each one is an excellent complement to your system, with the added benefit of being a CD player as well. Your VCR should reproduce "Hi-Fi" formats (e.g., VHS Hi-Fi) in addition to the regular linear audio tracks. These formats offer extended frequency response with dynamic range exceeding 80 dB. Moreover, almost all new films released for the home video market use them for the Dolby Stereo soundtrack.

SURROUND SOFTWARE

When you buy or rent a videotape or videodisc, be sure to look for the Dolby Surround logo on the package. Action-packed films (e.g., Batman) are especially known for using multi-channel sound to its fullest potential. Climactic scenes, like the rescue from the tank in Indiana Jones and the Last Crusade, will sound incredible on your home theater system equipped with the KC-X1. Currently (as of 1993), there are over 2500 movies with Dolby Surround soundtracks available (with many, many more on the way) for home use.

When viewing a stereo program off the air or on cable, look for the Dolby Surround logo in the opening or closing credits, or check your local television listings. When you see the logo, turn on THX CINEMA or Dolby Pro-Logic and enjoy the show in surround sound.

LOUDSPEAKERS

The KC-X1 has the capability to control six speaker channels — Front (left and right), Center, Surround (left and right) and Subwoofer. Maximum theater effect is obtained when the system is configured with all six speakers. Various configurations are possible by choosing whether or not to use a subwoofer or center speaker, or by using a small or large center speaker.

To enjoy surround playback with the THX CINEMA mode, we recommend using audio products bearing the "THX" logo specified by the Lucas Arts Entertainment Company. Audio equipment bearing this logo will thrill you with powerful and energetic effects generated by state-of-the-art electrical and acoustical processing.

Speaker layout

THX CINEMA

(Use speakers carrying THX mark, approved by Lucas Arts Entertainment Company.)

NORMAL mode : When the center speaker is compact.
WIDE BAND mode : When the center speaker is medium-sized or larger.

PHANTOM mode : When the center speaker is not used.

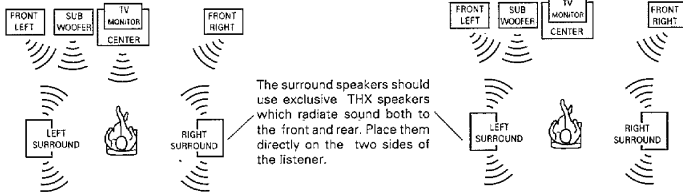

Set the SUB WOOFER switch on the rear panel of the main unit to ON.

Dolby Pro Logic

NORMAL mode : When the center speaker is compact.
WIDE BAND mode : When the center speaker is medium-sized or larger.

PHANTOM mode : When the center speaker is not used.

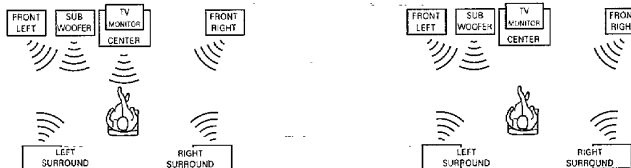

The sub woofer can be used according to your preference. When it is used, set the SUB WOOFER switch on the rear panel of the main unit to ON.

Dolby 3 Stereo

NORMAL mode : When the center speaker is compact.
WIDE BAND mode : When the center speaker is medium-sized or larger.

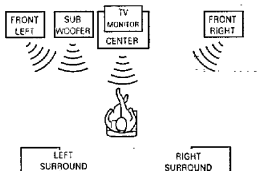

The sub woofer can be used according to your preference. When it is used, set the SUB WOOFER switch on the rear panel of the main unit to ON.

DSP LOGIC

The sub woofer can be used according to your preference. When it is used, set the SUB WOOFER switch on the rear panel of the main unit to ON.

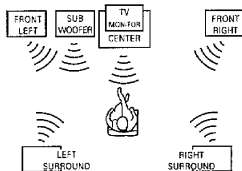

MONO

The audio is monaural. Monaural audio is output from the left and right front speakers only when the THX CINEMA and DOLBY PRO LOGIC SURROUND are set to the "PHANTOM" mode.

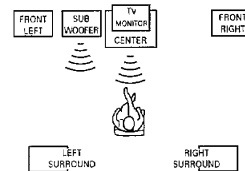

The sub woofer can be used according to your preference. When it is used, set the SUB WOOFER switch on the rear panel of the main unit to ON.

The SUB WOOFER switch on the rear panel of the unit should be operated only while the power is OFF. For the position of the sub woofer, also read the instruction manual supplied with your sub woofer.

System connections

Make connections as shown below. When connecting the related system components, refer also to the instruction manuals of the related components.
Do not plug in the power lead until all connections are completed.

For the connection of video components, please refer to page 9.

■ Connection in case the KC-X1 is combined with KENWOOD KM-X1 power amplifier

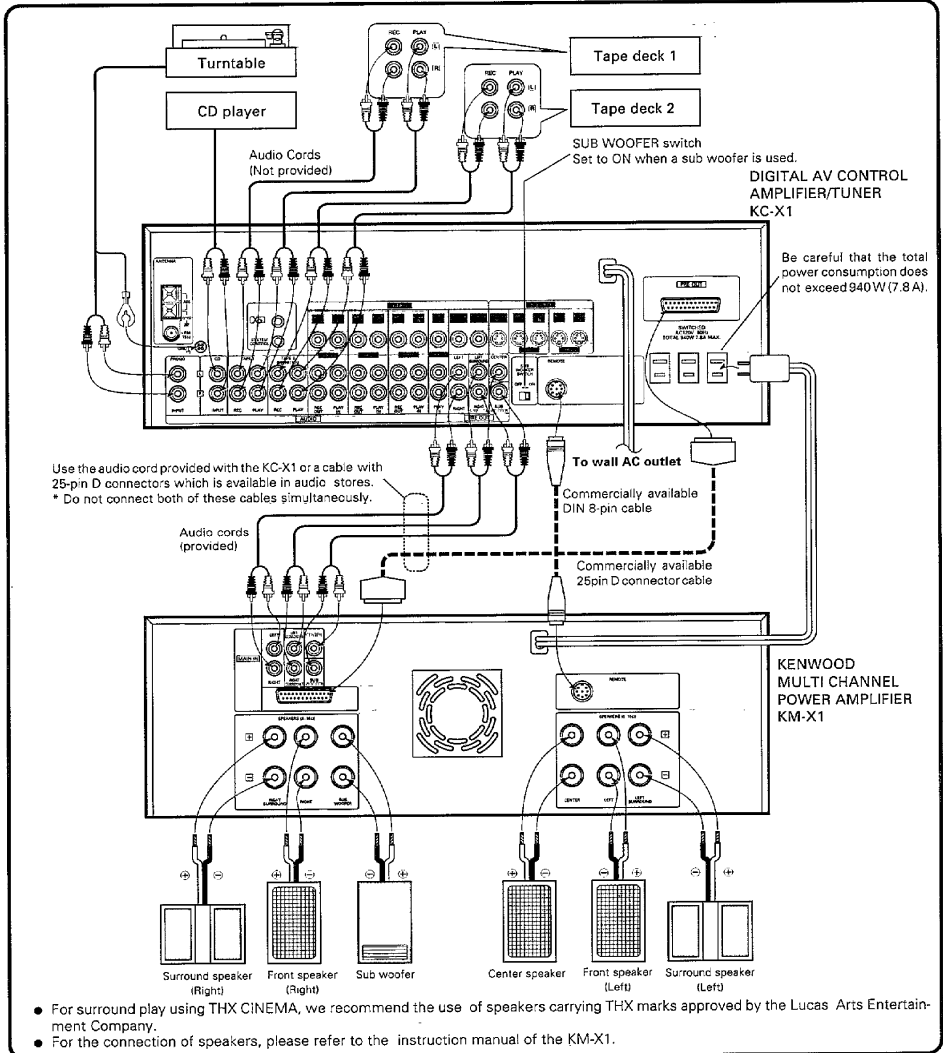

* When the DIN 8-pin cable and 25-pin D connector cable are not used, do not plug anything into the REMOTE and 25-pin D connectors.

■ Connection in case the KC-X1 is combined with other power amplifier than KENWOOD KM-X1

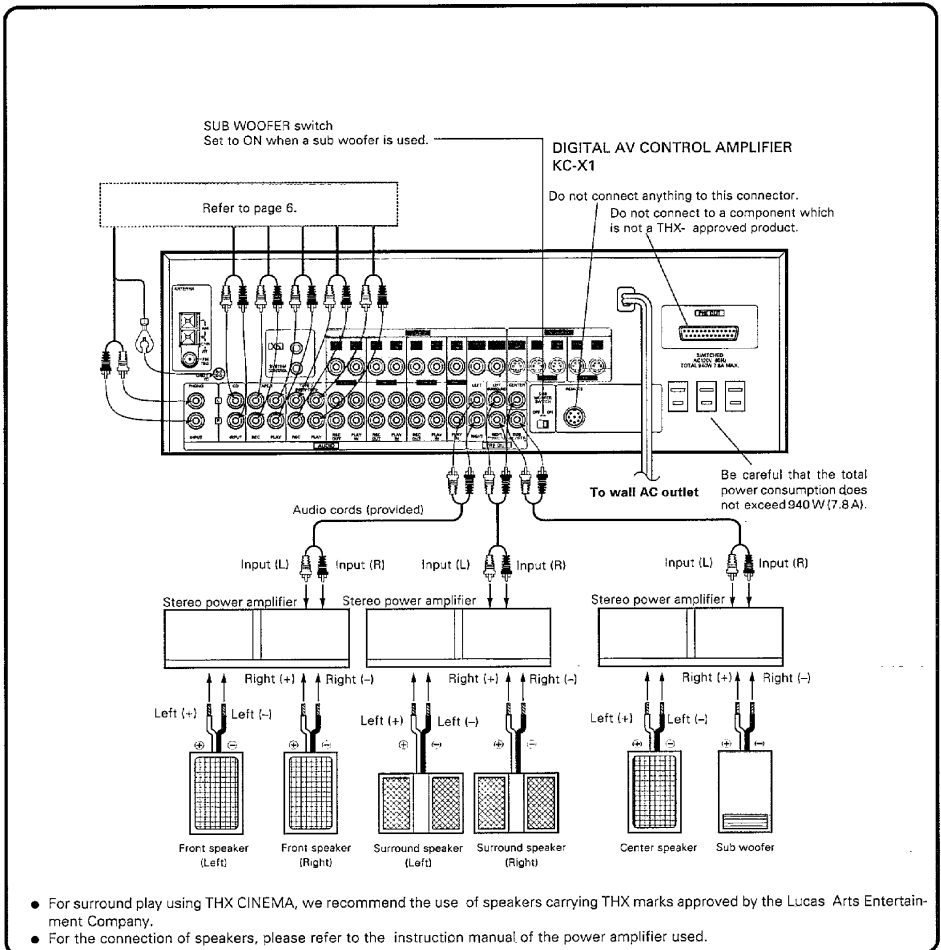

Notes:

1. Connect all cords firmly. If connections are loose, there could be loss of sound or noise produced.
2. When plugging and unplugging connection cords, be sure to first remove the power cord from the AC outlet. Plugging / unplugging connection cords without removal of the power cord can cause malfunctions or damage to the unit.
3. Do not connect up a power source which is larger than that indicated on the socket at the rear of the unit.
4. When the DIN 8-pin cable and 25-pin D connector cable are not used, do not plug anything into the REMOTE and 25-pin D connectors.

System connections

Connection method to each antenna terminal

① Push lever.

② Insert cord.

③ Return lever.



■ AM loop antenna connection

The supplied antenna is for indoor use. Place it as far as possible from the main system, TV set, speaker cords and power cord, and set it to a direction which provides the best reception.

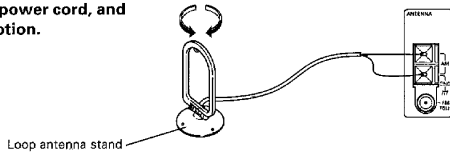

■ AM outdoor antenna connection

If the reception is poor when the AM loop antenna is used, distribute a vinyl-coated wire of more than 6 meters outdoors, without disconnecting the loop antenna.

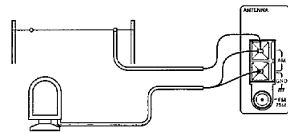

■ FM indoor antenna connection

The supplied antenna is for indoor use. For stable reception, remove the indoor after installing an outdoor antenna as soon as possible.

① Find the position that provides best reception.

② Fix two ends.

Connect to the screw terminals.

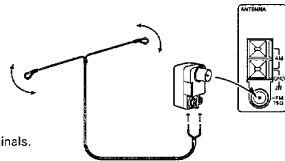

■ FM outdoor antenna connection

It is recommended to install an exclusive FM outdoor antenna to capture FM broadcast with high sound quality. Use a coaxial cable for the connection between the outdoor antenna and FM ANTENNA terminal on the rear panel. For the connection between the coaxial cable and FM ANTENNA terminal, please refer to the illustration.

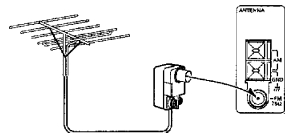

■ 75 Ω coaxial cable connection

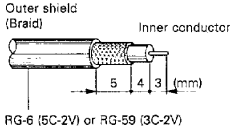
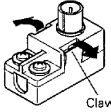
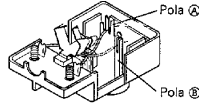
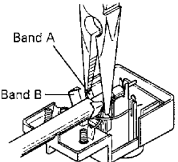
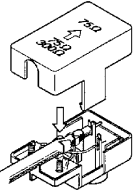
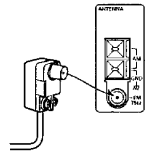
| | | |
|---|--|---|
| <p>① Arrange the coaxial cable as illustrated.</p>  <p>Outer shield (Braid) Inner conductor 5 4 3 (mm) RG-6 (5C-2V) or RG-59 (3C-2V)</p> | <p>② Open the antenna adaptor. Open the claws with the fingers to release the lock and pull out the cover.</p>  <p>Claw</p> | <p>③ Remove the inner conductor from the groove of pole ④ and insert it in the groove of pole ⑤.</p>  <p>Pole ④ Pole ⑤</p> |
| <p>④ Insert into the slit on the clip. Fasten the bands A and B, using a pair of pliers.</p>  <p>Band A Band B</p> | <p>⑤ Close the cover.</p>  | <p>⑥ Connect the adaptor to the antenna terminal.</p>  |

Note:
When using a 300Ω feeder cable, insert its cores into the groove of pole A.

■ Connection of video components

Before proceeding to operation, read carefully the instruction manuals of the video components used.

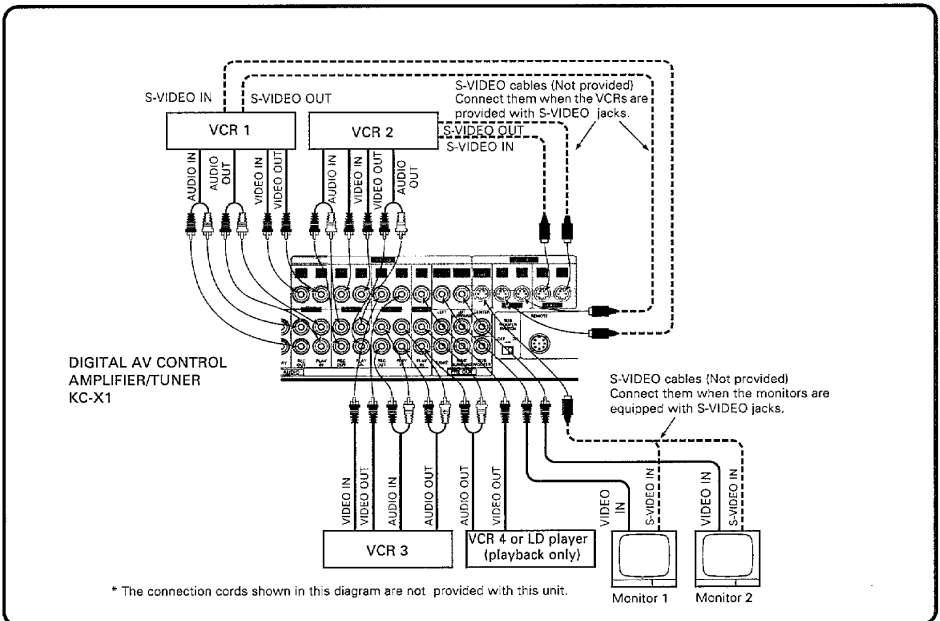

■ Connection for system control operation

By connecting this unit to other KENWOOD system components equipped with SYSTEM CONTROL terminals, such as a cassette deck, CD player and/or analog disk turntable, the following convenient operations will be available.

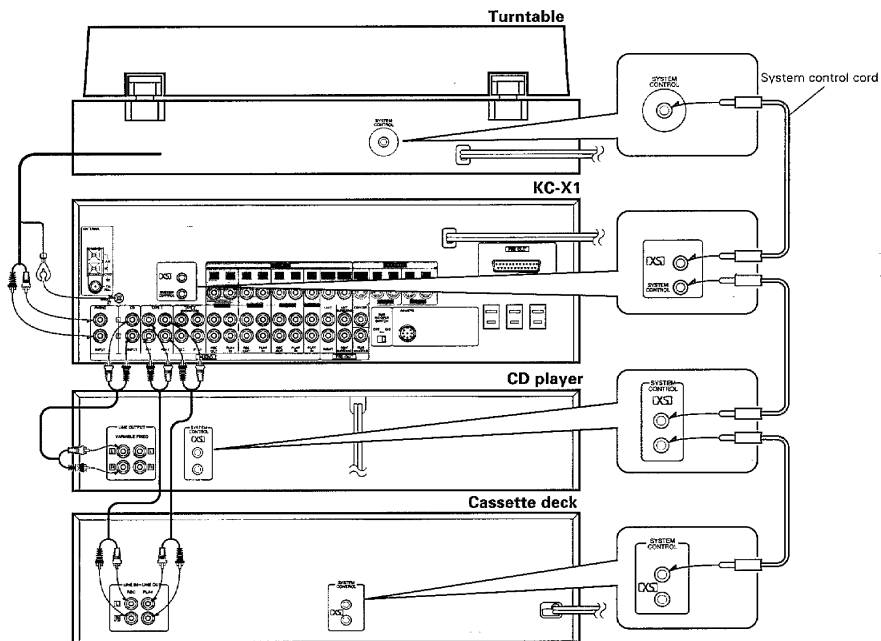

System control connection

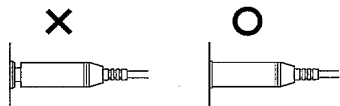

- Be sure to insert the system control cord plugs fully into the SYSTEM CONTROL terminals.
- If the system control cord and audio cords are not connected properly, the automatic system governing remote control and system functions will not operate.

Automatic play operation

When starting play with the turntable, cassette deck, or CD player connected to this unit, press the desired input selector keys on this unit. The turntable, cassette deck, or CD player will automatically enter play mode.

In the same way, pressing the Play key of the turntable, cassette deck, or CD player will automatically switch the input selector on this unit to the component on which the Play key is pressed.

Synchro recording

To record the sound from the CD player or turntable onto a tape with the cassette deck, press the CD or PHONO of the input selector keys and load a CD or record. Set the cassette deck to rec pause mode, then press the Play (start) key of the CD player or turntable. The cassette deck will start recording automatically, synchronized with the CD player or turntable starting play. For more details, refer to the instruction manual of the cassette deck.

Remote control

When the receiver, cassette deck, CD player and analog disk turntable are connected via the system control cords, these components can be controlled from the remote control unit supplied with this unit.

Controls and indicators

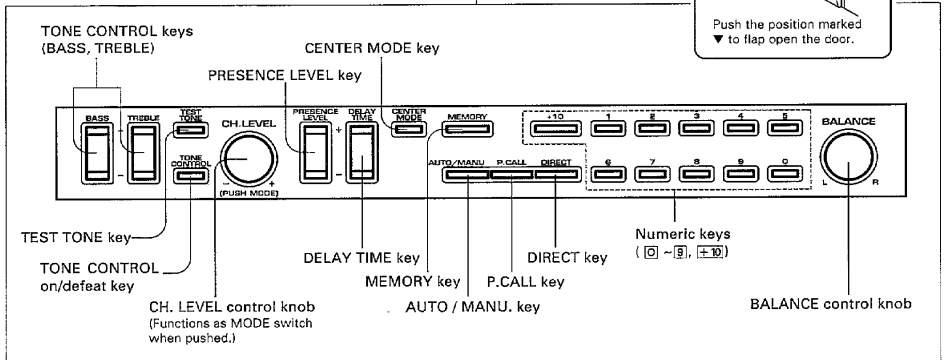
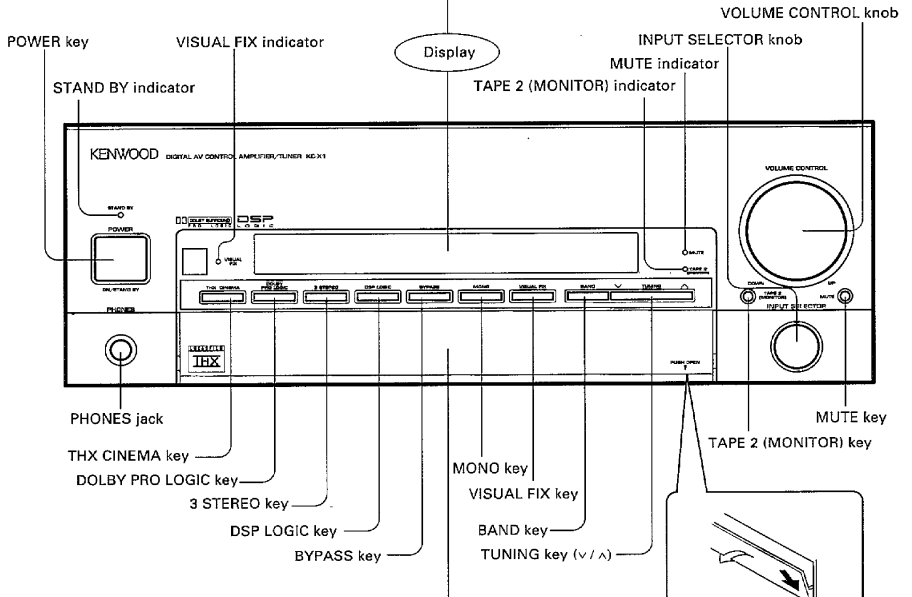
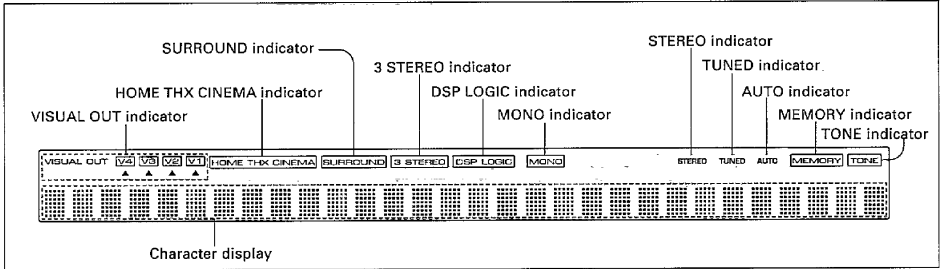

Operation of remote control unit

In addition to the remote control of the receiver unit, the provided remote control unit can control a KENWOOD cassette tape deck, CD player, turntable, graphic equalizer, etc., connected via the KENWOOD system control cord.

The operation keys on the remote control unit can be used in two ways according to the position of the MODE switch.

AUDIO mode : The operation keys can control this unit and KENWOOD system components which are connected to this unit via the system control cords.

AUX mode : Remote control functions of video components, etc., can be programmed under any keys so that they can be controlled from this unit.

■ Loading batteries

1 Remove the cover.

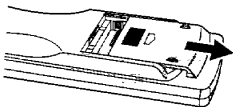

- While gently pressing the cover located on the rear of the remote control unit, slide it in the direction of the arrow.

2 Insert batteries.

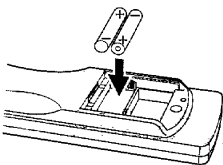

- Insert two AAA-size (R03) batteries as indicated by the polarity marking.

3 Close the cover.

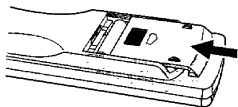

■ Operation procedure

The operating range varies depending on the temperature, humidity and other environmental conditions. In normal cases, the operating range is as shown in the illustration below.

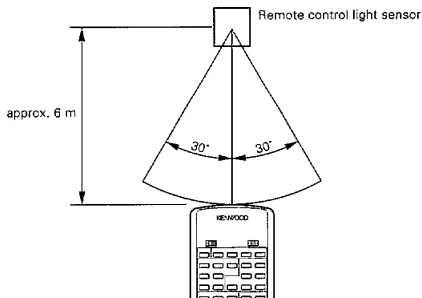

- When two operation keys on the remote control unit are pressed successively, press each key securely reserving an interval of more than 1 second for each press.
- Components connected via the system control cords, such as the CD player, can also be remote-controlled. In this case, please read the instruction manual supplied with your CD player.

Notes:

1. The supplied batteries are intended for use in operation checks. Therefore, their lives may be shorter than ordinary batteries.
2. When the remote-controllable distance gets shorter than before, replace both batteries with new ones.
3. Malfunction may occur if direct sunlight or the light of a high-frequency lighting fluorescent lamp enters the remote control light sensor. In such a case, change the system installation position to prevent the malfunction.

Replacing batteries

1. If the TRANSMIT indicator does not light even when the operation key is pressed, the batteries are exhausted. Replace the batteries. We recommend that the alkaline batteries (LR03) which have longer service life be used.
2. The programmed contents are not immediately lost when the batteries are removed for replacement. However, they could be lost if the unit is left without batteries for more than 3 minutes. In such a case, the programming should be performed again. The function signals of the non-learning, or fixed keys are not lost even in this case.

■ Names and functions of remote control keys (AUDIO mode)

To remote control KENWOOD components connected to this unit via the system control cords, set the LEARN/USE switch and AUDIO/AUX switch as shown in the illustrations below.

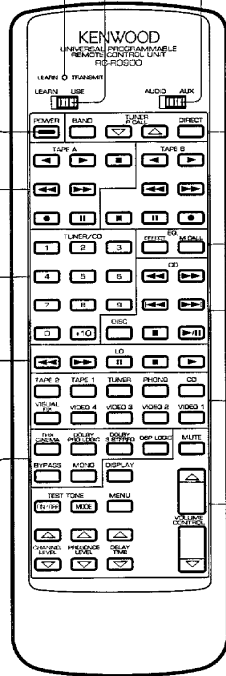
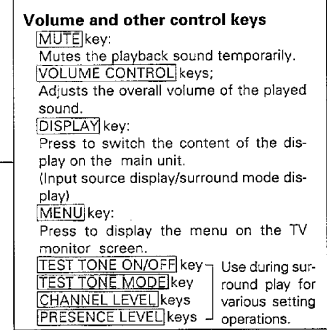
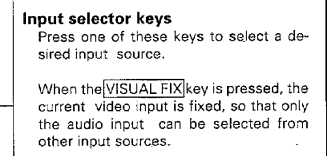
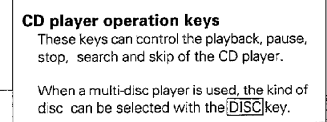
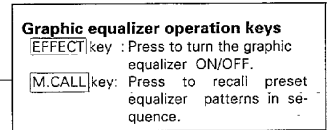
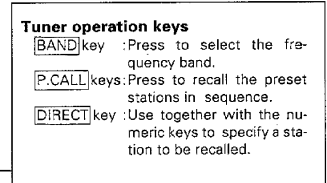
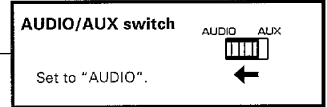
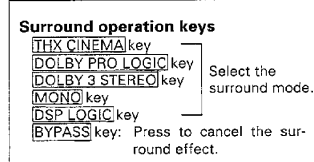
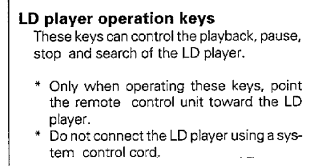
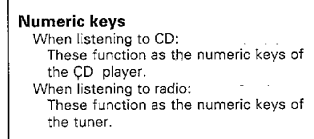
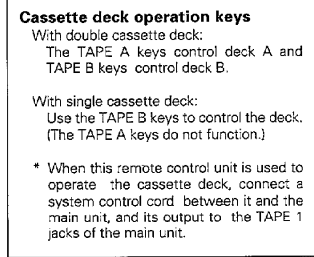
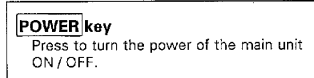
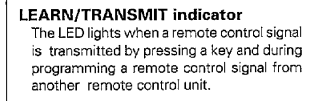
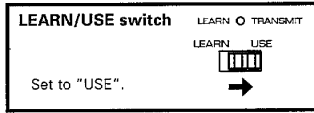

Operation of remote control unit

■ Programming functions from other remote control units

Use the following procedure to program remote control signals of other remote control units in this unit. Remote control signals can be programmed under all keys in each of the AUDIO and AUX modes.

1 Set to LEARN / USE switch to LEARN.



2 Select the mode.

- When the AUDIO mode is selected, the functions preprogrammed when the unit left the factory can be replaced with other functions.



3 Place the transmitter section of this remote control unit so that it faces directly toward the transmitter section of the other remote control unit.

- Approx. 2 ~ 5 cm

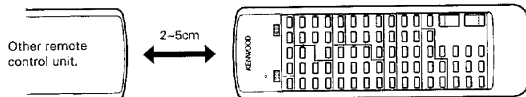

4 Program a remote control function.

① Press the key you want to program a function under it.

- The LEARN indicator lights up.

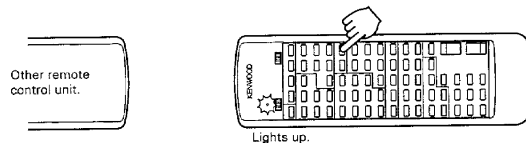

② On the other remote control unit, press and hold the key corresponding to the function you want to program.

- When the lighted LEARN indicator blinks twice and then goes out, programming is completed.
- Keep pressing the other remote control unit's operation key until the LEARN indicator goes out.
- To continue programming other keys, repeat steps 4-① and ②.

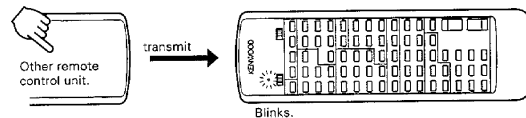

Notes:

- If the other remote control unit has a strong light output, programming may not be carried out properly. If this occurs, move the two remote control units farther away from each other and program again.
- If the LEARN/TRANSMIT indicator blinks during programming, either the selected key cannot be programmed or the function was not programmed properly. Carry out the programming procedure again.
- Functions of remote control units which do not use infrared signals or which use a special signal modulation system cannot be programmed into this remote control unit. Also, programming is impossible when the remote control unit's memory becomes full.
- If more than 30 seconds elapse after pressing a learning key, the LEARN indicator will go out. Since programming is not possible if the LEARN indicator is not lighted, carry out the programming procedure again from step 3.
- If two or more leading keys are pressed on this remote control unit, the key pressed last will be programmed.
- This remote control unit should only be programmed with functions for operating AV equipment. Do not program functions for any other type of equipment (such as an air conditioner).

■ Checking the programmed content

1 Set to USE.

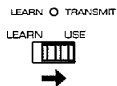

2 Select the mode.



- Select the mode to which the key to be checked belongs.

3 Press the key to be checked.

- Check if the component to be operated functions.

■ To change the programmed contents

Reprogram the desired key according to the "Programming functions from other remote control units" procedure.

- The previously programmed function is automatically deleted and replaced with the new function.

Overlay sheet

It is a good idea to write down the programmed contents of the operation keys on the overlay sheet. Peel off the protective sheet and write on the sheet using an oil-based felt tip pen or a pencil. Erase by rubbing firmly with a normal rubber eraser.

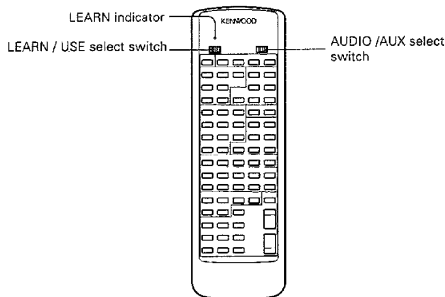
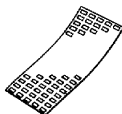

■ To erase all of the programmed contents

This procedure erases the programmed contents of all the learning keys in 3 modes, restoring the remote control unit to its initial state.

1 Set the LEARN / USE switch to LEARN.



2 Press one of the learning keys.

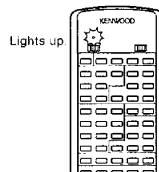

- The LEARN indicator lights up.

3 Remove the batteries and insert them again.

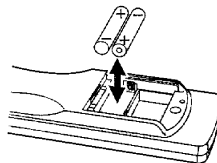

- Insert batteries within 30 seconds after pressing a programmable key.

Operating instructions

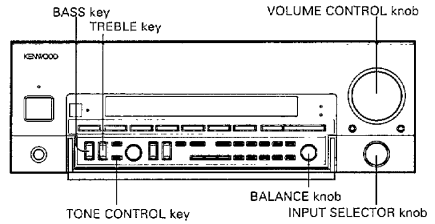
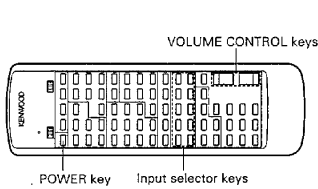

Basic operation

1 Turn the POWER ON.

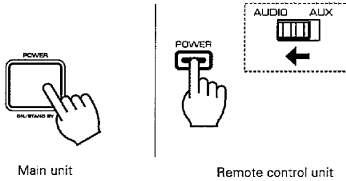

2 Select the input source.

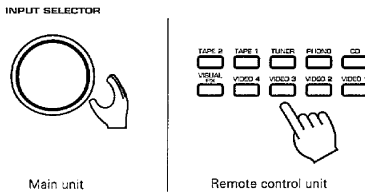

The source name characters appear on the display.

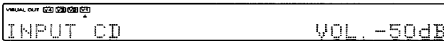

(Example when CD input is selected)

- The selected source component is played automatically if it is connected using a system control cord.

3 Play the source component.

4 Adjust the volume.

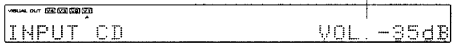
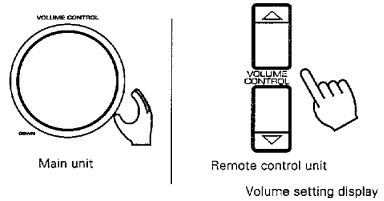

5 Adjust the left and right volume balance.

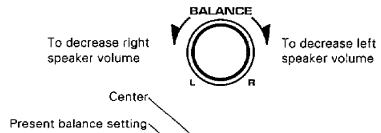

- The balance can be adjusted only in the bypass mode (when no surround mode is selected).

6 Adjust the tone controls.

- Set the tone control ON.
- Adjust the tone.

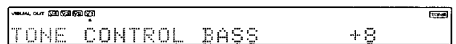
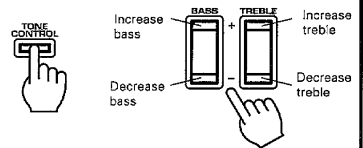

- The tone can be adjusted only in the bypass mode (when no surround mode is selected).

Notes:

- When the TAPE 2 key is set to ON, the source selected with the INPUT SELECTOR cannot be heard from the speakers. To listen to a source other than cassette deck 2, be sure to set the TAPE 2 key to OFF.
- The source selected with the INPUT SELECTOR is backed up for a few days even when the power cord is unplugged. After this period, the tuner is automatically selected when the power is supplied.

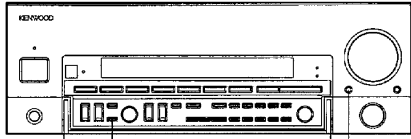

TONE CONTROL key

TAPE 2 (MONITOR) key

Defeating the tone control function

Main unit only

The **TONE CONTROL** key can be used to switch the tone control function to ON or DEFEAT only in the bypass mode (when no surround mode is selected).



Each press switches ON and DEFEAT alternately.

When TONE CONTROL is ON:

The signal is supplied through the tone control circuitry so that the tone is adjusted.

TONE lights up.

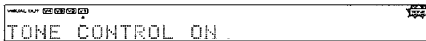

When TONE CONTROL is DEFEAT:

The signal is not supplied through the tone control circuitry. The tone cannot be adjusted, but the sound purity improves because the signal path is simpler.

Goes off.

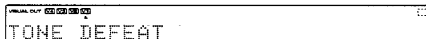

- When a surround mode is selected, the tone control is automatically set to "DEFEAT".

Operating the TAPE2 (MONITOR) key

Regardless of the input source being selected, a single press of the **TAPE2** key allows to select the input source connected to the TAPE2 (MONITOR) input jacks. Press the **TAPE2** key again to return to the original input source.

Main unit



Remote control unit

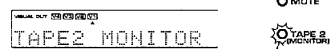

Lights when TAPE2 is selected.

STAND BY mode of POWER switch

When the power cord of this system is plugged into an AC outlet, the STAND BY indicator lights up regardless of the ON / OFF setting of the POWER switch. This indicates that a small amount of current is being supplied to the unit to back up the memory contents. This mode is referred to as the Stand By mode. While the STAND BY indicator is lit, the power of the system can be switched ON / OFF from the remote control unit.

Operating instructions

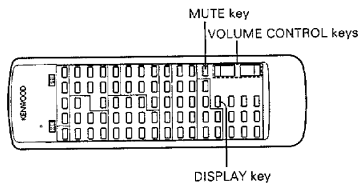
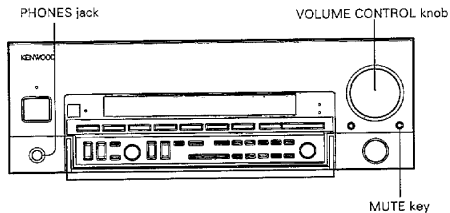

■ To mute the sound temporarily

Press the MUTE key.



Main unit



Remote control unit

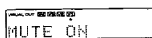
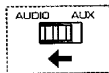

- Pressing the key again resumes the previous volume.

DISPLAY key

When a surround mode is selected, pressing the **DISPLAY** key of the remote control unit switches the display mode of the display on the main unit.

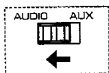

Each press switches the input source display and surround mode display alternately.

Input source display

INPUT VIDEO1

Surround mode display

THX CINEMA DOLB

■ Listening through headphones

1 Set the Speaker switch to OFF.

Operate on the power amplifier.

2 Insert the headphone plug into the headphones jack.



3 Adjust the volume.



Main unit

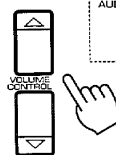

Remote control unit

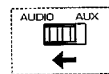

- Minimize the volume setting before switching the Speakers switch to ON.

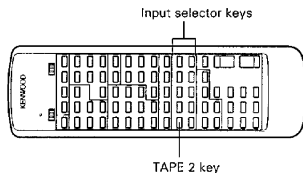
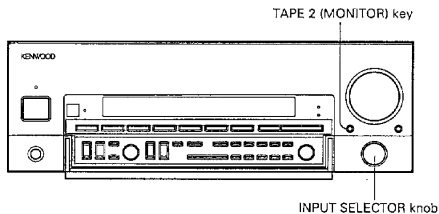

■ Ordinary tape recording

1 Select the source to be recorded.

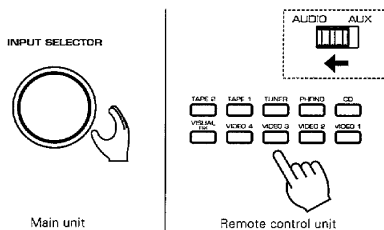

2 Set cassette deck 1 or 2 in the record-pause mode.

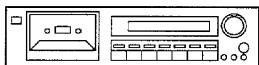

3 Play the source component to be recorded, and start recording it on the cassette deck.

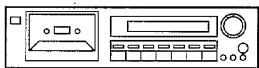

- In case of tape dubbing (TAPE 1 → TAPE 2), play the cassette deck connected to TAPE 1 and record on the cassette deck connected to TAPE 2.

Note:

The input to this unit cannot be changed over while the cassette deck connected to this unit via the system control cord is in the record mode. When it is required to change the input source, put the cassette deck in the stop mode beforehand.

■ Dubbing from TAPE2 to TAPE1

1 Press the TAPE 2 key.

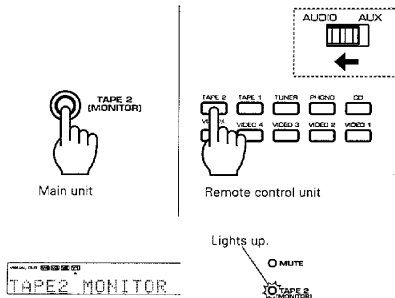

2 Select a source other than TAPE 1.

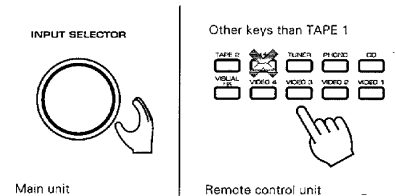

- Recording on the TAPE1 deck is not possible while the TAPE1 input is selected.

3 Play cassette deck 2 and start recording on cassette deck 1.



Start recording on deck 1.

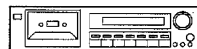

Start playback on deck 2.

- Do not select TAPE 1 while dubbing.

Note:

For the tape-to-tape dubbing procedure using a double-deck type cassette tape deck, please read the instruction manual provided with the double-deck type cassette tape deck.

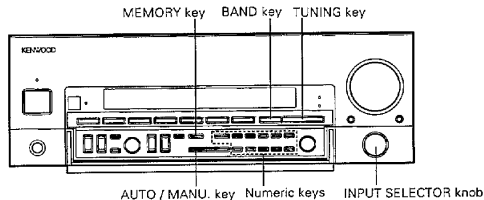

■ Receiving broadcast stations and storing them in memory (preset operation)

1 Select the TUNER position.

INPUT SELECTOR

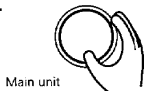

Main unit

Frequency display

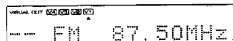

2 Select the broadcast band.



Main unit

The bands are switched as follows every time the **BAND** key is pressed.



3 Select the tuning mode.



Main unit

The indication changes every time the key is pressed.

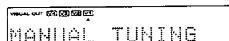

Lights up in the AUTO mode.



- Normally, select the auto mode (with AUTO lighted).

4 Tune the desired station.

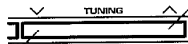

To decrease frequency

To increase frequency

- The TUNED indicator lights up when a station is received.
- Use manual tuning mode when the radio wave is weak and noisy. At this time, the stereo FM broadcast is received in monaural mode.

Auto tuning mode

Press once. (Tuning stops automatically when a station is received.)

Manual tuning mode

Press repeatedly, or press and hold, until the desired station is received.

5 Store the station in preset memory.

- ① Press the **MEMORY** key.

MEMORY lights up for approx. 5 sec.

- Proceed to step ② before **MEMORY** stops lighting.

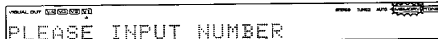

- ② Press the desired numeric key.

Examples of input

To select preset No. 15: **+10 5**

To select preset No. 20: **+10 +10 0**

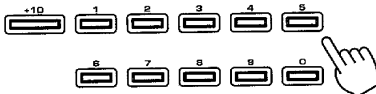

- When a station has previously been preset under the numeric key pressed, the newly preset station replaces the previous station.
- When preset is to be continued, repeat steps 2 to 5.
- Up to 40 broadcast stations can be preset regardless of the broadcasting bands.

Storing in preset No 15.

MEMORY goes off.

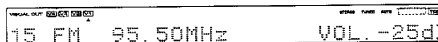

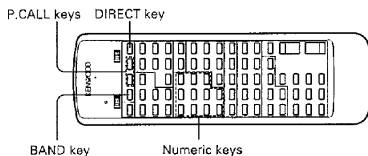
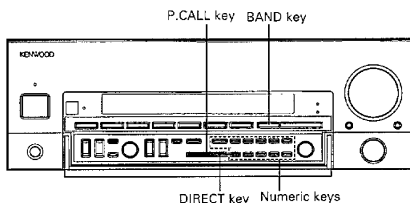

■ Receiving a preset station

Select the desired station.

Press the numeric key under which the station is preset.

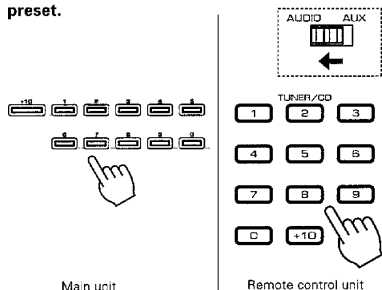

- The frequency of the station received will be displayed.

■ Listening to all preset stations in sequence (PRESET CALL)

Press the P.CALL key.

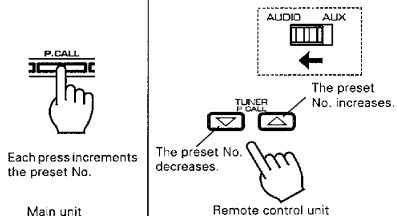

Last channel memory

When the band selector is switched or when the input selector is switched from another source to TUNER, the last received station is recalled for each of FM, AM when the power is switched ON.

■ Direct tuning of radio stations

If you know the frequency of the desired station, it can be received directly by inputting the frequency using the numeric keys.

1 Select the broadcast band.

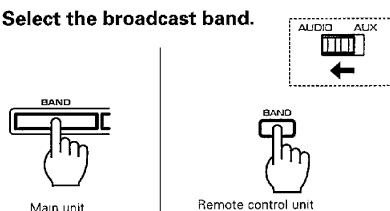

2 Press the DIRECT key.



PLEASE INPUT FREQUENCY

3 Input the frequency of the desired station by pressing the numeric keys.

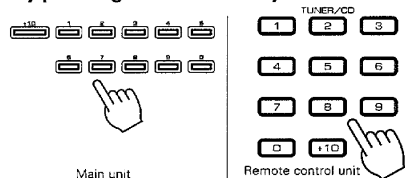

Example of input

| Desired station | Order of pressing numeric key |
|-----------------|-------------------------------|
| FM 90 MHz | [9], [0], [0] |
| FM 102.5 MHz | [1], [0], [2], [5] |
| AM 810 kHz | [8], [1] |
| AM 1260 kHz | [1], [2], [6] |

- If you commit a mistake in the input of numeric keys, press the **[DIRECT]** key twice, and re-start the input from step 3.

Operation with video components

For the connections and operations, also read carefully the instruction manuals supplied with video components to be connected.

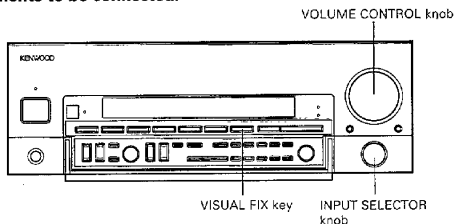

When connect to the KENWOOD LD player having system control terminal, do not connect anything to the system control terminal of the LD Player.

■ Playback of videotape

1 Switch the power of the monitor TV ON.

2 Select the VIDEO input.

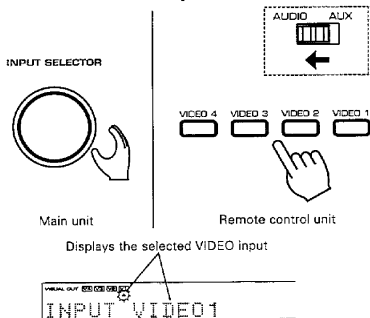

- When an input selector key other than VIDEO 1 is pressed, the audio input of the selected source will be played in place of the audio input from VIDEO 1.

3 Play the VCR.

4 Adjust the volume.

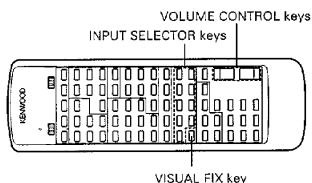
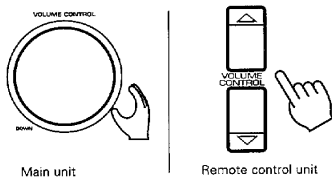

■ Recording of video source

1 Connect the player component to the VIDEO jacks.

- A video player deck, video camera, LD player, DBS tuner, etc., can be connected.

2 Select the player component as the input source.

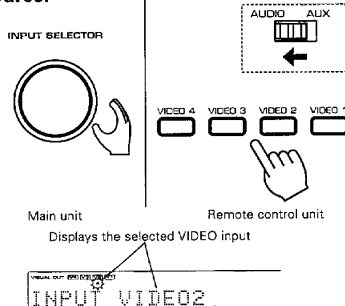

3 Play the source.

4 Put the VCR in the record mode.

VISUAL FIX key

You can use this function to lock in a selected video input (DBS/LD, VIDEO). Once a video input is selected and VISUAL FIX is ON, the video signal will not change even if the input selector is switched to another video input.

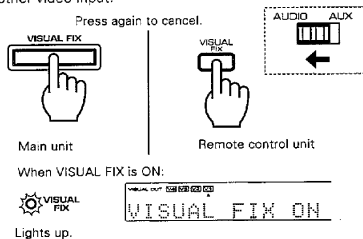

Presence effect

This system incorporates the following Surround functions which can provide the feeling of presence in a concert hall or theater or the powerful effects of theater movies recorded with Dolby Surround audio. For details, refer to each operation procedure on the following pages.

1. THX CINEMA

This is an improvement, with the theme of "A No - Compromise Home Cinema Experience", of the Dolby Pro Logic reproduction system to make it suitable for smaller spaces. In this mode, video software carrying  DOLBY SURROUND mark can be played.

2. DOLBY PRO LOGIC SURROUND

When video software carrying  DOLBY SURROUND mark is played in this mode, a similar effect to the DOLBY SURROUND effect in movie theaters can be enjoyed.

3. DOLBY 3 STEREO

When the left and right speakers are apart, the acoustic image on the center tends to be poor. In such a case, the DOLBY 3 STEREO mode improves the center acoustic image using a directivity enhancement processing.

4. DSP LOGIC

When an ordinary video source is played, this mode allows to create a sound field effect similar to movie theaters by means of digital signal processing.

5. MONO

This mode is used in case the original audio of the source is monaural, for example with old movies. With this mode, a center speaker is used to output the mixture of left and right sound. When the THX CINEMA and DOLBY PRO LOGIC SURROUND are set to the "PHANTOM" mode which does not use a center speaker, monaural audio is output from the left and right front speakers.

Delay time

As shown in the example of illustration, the sound of piano played on the stage attains the ears of listener as a synthesis of the direct sound from piano, the indirect sounds which are reflected once or twice by the reflectors, ceiling and side and back walls, and the reverberation sounds which repeat infinite reflections until they fade out completely. The indirect sounds always pass through longer routes compared to the direct sound. The delay between the direct and indirect sounds is called the DELAY TIME, and the level of the indirect or reverberated sounds is called the PRESENCE LEVEL. The indirect sounds accompanied with delay play a very important role in providing better sound effects and the feeling of presence of concert halls, etc. The acoustic field also varies depending on the speaker arrangement. It is recommended to try various delay time setting to obtain the best sound field possible.

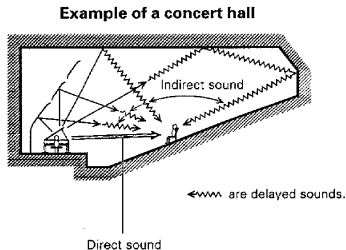

Setting the Delay time

DOLBY PRO LOGIC only

The delay time should be adjusted according to the difference between the distance from the listening position to the front speakers and the distance to the rear (surround) speakers. Determine the appropriate delay time using the formula shown below. Relationship between the positioning of the rear (surround) speakers and the delay time at the listening position.

$$\text{Delay time} = 20 \text{ ms} + 3 \text{ ms} \times (A - B) \text{ m}$$

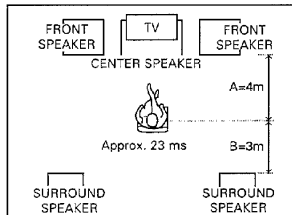
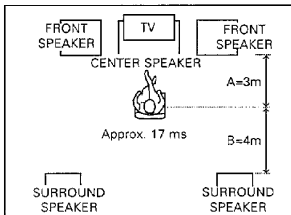
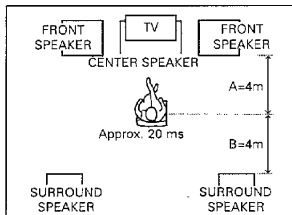

THX CINEMA

When video software carrying **DX [DOLBY SURROUND]** mark is played, this mode provides the similar Dolby Surround effect to movie theaters.

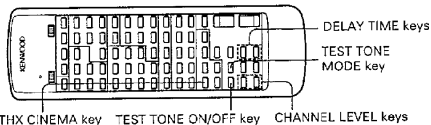

THX CINEMA adjustment

1 Set the THX CINEMA mode.

Lights up.

Selected mode name display.
When the display is in the INPUT mode, this returns to the input source display in a few seconds.

2 Select the center mode.

Operate on the main unit

Every time the key is pressed, the center mode is switched.

→ NORMAL → WIDEBAND → PHANTOM →

NORMAL mode : Select when the center speaker is compact.
WIDEBAND mode : Select when the center speaker is medium-sized or larger.
PHANTOM mode : Select when the center speaker is not used.

- If you cannot determine whether your center speaker belongs to the compact size or medium size, try both modes and select the optimum one.

3 Turn on the test tone.

For the content of the display which appears on the TV monitor screen, refer to page 35.

4 Adjust the volume balance.

Adjust so that the test tone volumes are the same on all speakers.
(The sub woofer volume can be set as desired.)

① Set the volume level to 0 dB.

Current volume level is displayed

② Press the [MODE] key.

The speaker generating the noisy test tone is changed every time the key is pressed.

In NORMAL or WIDE BAND mode:
 → Left → Center → Right → Right surround → Left surround
 Sub woofer ←

In PHANTOM mode:
 → Left → Right → Right surround → Left surround
 Sub woofer ←

③ Adjust the volume balance.

- Adjust within a range of -12 to +12 dB.

The level being adjusted is displayed.

5 Stop generating the test tone.

6 Set the delay time.

- The delay time can be adjusted in the range from 15 to -30 ms.
- When one of the [DELAY TIME] keys is pressed, the delay time is displayed and varied in 1 ms steps per press the key.
- Once the delay time is set, it is stored automatically as a common setting with DOLBY PRO LOGIC. Unless it is set again, the same delay setting will be applied every time THX CINEMA or DOLBY PRO LOGIC is selected.

VOLUME CONTROL Keys

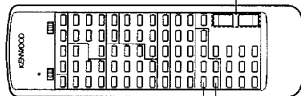

■ THX CINEMA playback

Before using the THX CINEMA mode, be sure to perform the "THX CINEMA adjustment" procedure.

1 Set the THX CINEMA mode.

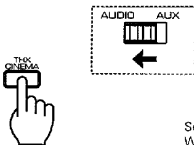

Lights up.

THX CINEMA DOLBY PRO LOGIC

Selected mode name display.
When the display is in the INPUT mode, this returns to the input source display in a few seconds.

2 Check the center mode. Operation on the main unit



Pressing once displays the current center mode.
Pressing the key while the current mode is displayed switches the mode.

CENTER MODE WIDEBAND

- Normally, the last mode used is held in memory. If it is different from the required mode, select the mode which was used in step 2 of the "THX CINEMA adjustment" (page 26).

3 Play a software program encoded with Dolby Surround.

4 Adjust the volume.

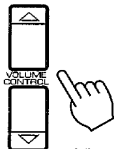

INPUT VIDEO1 VOL. -20dB

Adjusts the overall volume.

- When the level balance of the center and surround speakers is not good, perform the "THX CINEMA adjustment" procedure again.
- The tone control is not possible while a surround mode is selected.

To return to normal stereo playback



SURROUND BYPASS

DOLBY PRO LOGIC SURROUND

When video software carrying **DX DOLBY SURROUND** mark is played, this mode provides the similar Dolby Surround effect to movie theaters.

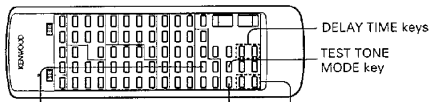

DOLBY PRO LOGIC key TEST TONE ON/OFF key CHANNEL LEVEL keys

■ DOLBY PRO LOGIC adjustment

1 Set the DOLBY PRO LOGIC mode.

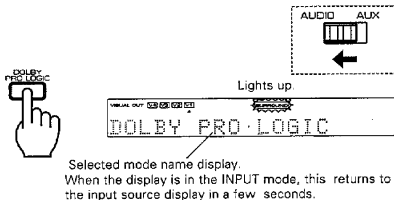

2 Select the center mode.

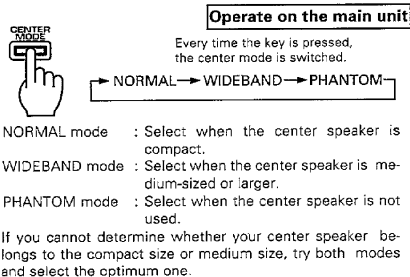

3 Turn on the test tone.

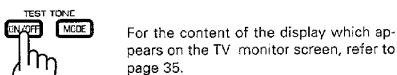

4 Adjust the volume balance.

Adjust so that the test tone volumes are the same on all speakers.

(The sub woofer volume can be set as desired.)

① Press the MODE key.

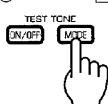

The speaker generating the noisy test tone is changed every time the key is pressed.

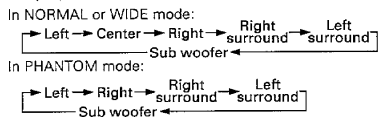

② Adjust the volume balance.



- Adjust within a range of -12 to +12 dB.

The level being adjusted is displayed.



5 Stop generating the test tone.



6 Set the delay time.



- Calculate the proper delay time for Dolby Surround by referring to the illustration below.
- The delay time can be adjusted in the range from 15 to 30 ms.
- When one of the [DELAY TIME] keys is pressed, the delay time is displayed and varied in 1 ms steps per press the key.
- Once the delay time is set, it is stored automatically as a common setting with THX CINEMA. Unless it is set again, the same delay setting will be applied every time THX CINEMA or DOLBY PRO LOGIC is selected.

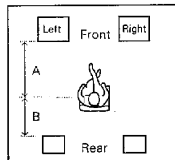

Delay time (ms) = 20 ms + 3 ms (A - B)
 A : Distance of front speaker (m)
 B : Distance of rear speaker (m)

■ DOLBY PRO LOGIC playback

Before using the DOLBY PRO LOGIC mode, be sure to perform "DOLBY PRO LOGIC adjustment" procedure.

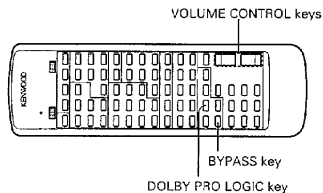

1 Set the DOLBY PRO LOGIC mode.

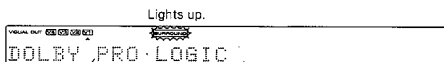
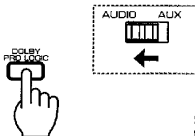

Selected mode name display.
When the display is in the INPUT mode, this returns to the input source display in a few seconds.

2 Check the center mode. Operation on the main unit

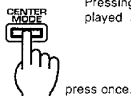

Pressing once displays the current center mode.
Pressing the key while the current mode is displayed switches the mode.

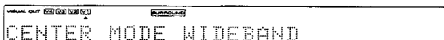

- Normally, the last mode used is held in memory. If it is different from the required mode, select the mode which was used in step 2 of the "DOLBY PRO LOGIC adjustment" (page 28).

3 Play a software program encoded with Dolby Surround.

4 Adjust the volume.

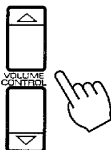

Adjusts the overall volume.

- When the level balance of the center and surround speakers is not good, perform the "DOLBY PRO LOGIC adjustment" procedure again.
- The tone control is not possible while a surround mode is selected.

To return to normal stereo playback

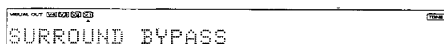

DOLBY 3 STEREO

By using an additional center speaker, this mode provides a secure positioning of the center channel sound, such as words.

■ Dolby 3 STEREO adjustment

1 Set the Dolby 3 STEREO mode.



When the display is in the INPUT mode, this returns to the input source display in a few seconds.

Selected mode name display.

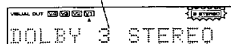

2 Select the center mode.



Operation on the main unit

Every time the key is pressed, the center mode is switched.

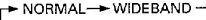

NORMAL mode : Select when the center speaker is compact.

WIDE BAND mode : Select when the center speaker is medium-sized or larger.

- If you cannot determine whether your center speaker belongs to the compact size or medium size, try both modes and select the optimum one.

3 Turn on the test tone.



For the content of the display which appears on the TV monitor screen, refer to page 35.

4 Adjust the volume balance.

Adjust so that the test tone volumes are the same on all speakers.
(The sub woofer volume can be set as desired.)

- ① Press the **MODE** key.

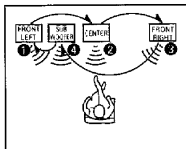
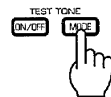

The speaker generating the noisy test tone is changed every time the key is pressed.

- ② Adjust the volume.



- Adjust within a range of -12 to +12 dB.

5 Stop generating the test tone.

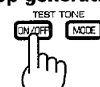

Press the TEST TONE ON / OFF key.

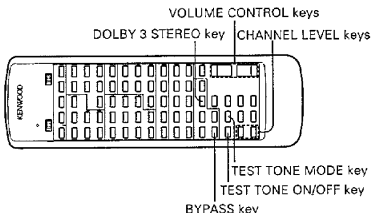

■ Dolby 3 STEREO playback

1 Set the Dolby 3 STEREO mode.



Lights up.

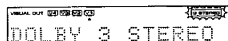

2 Select the center mode.

Operation on the main unit



Every time the key is pressed, the center mode is switched.

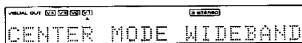
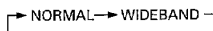

- Usually, the last center mode is stored in memory. If a different mode is displayed, select the mode set in step 2 of the "DOLBY 3 STEREO adjustment" procedure.

3 Play a stereo software program or a Dolby surround program.

4 Adjust the volume.

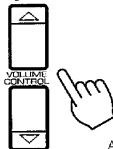

Adjusts the overall volume.

- When the level balance of the center speaker is not good, perform the adjustment procedure again.
- The tone control is not possible while a surround mode is selected.

To return to normal stereo playback

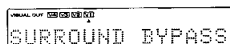

DSP LOGIC

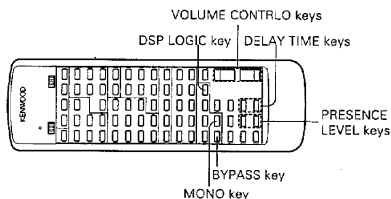

■ DSP LOGIC playback

When an ordinary source is played, this mode allows to create a sound field effect similar to movie theaters by means of digital signal processing.

1 Set the DSP LOGIC mode.

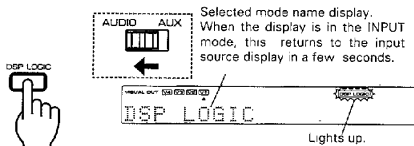

2 Play video software.

3 Adjust the delay time.

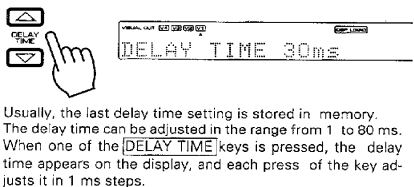

4 Adjust the presence level.

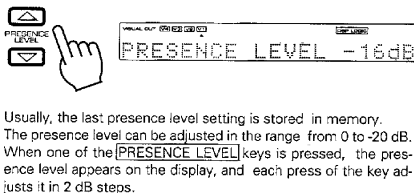

5 Adjust the volume.

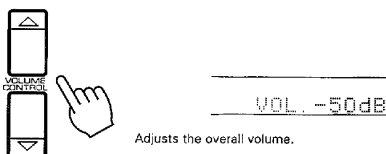

- The tone control is not possible while a surround mode is selected.

To return to normal stereo playback



- The delay time and presence level settings are stored in memory.

■ MONO mode playback

The MONO mode is suitable for sources with monaural audio, such as an old movie.

Press the [MONO] key.



Press the [BYPASS] key to return to stereo playback.

- Even when a stereo source is played, the reproduced sound is monaural and output from the center speaker.
- Monaural audio is output from the left and right front speakers only when the THX CINEMA and DOLBY PRO LOGIC SURROUND are set to the "PHANTOM" mode.
- The sub woofer output is the same as other modes.

Information display on TV monitor screen

This function allows to display various setting conditions and the list of preset stations on the screen of the TV monitor connected to the MONITOR OUT jack. (They cannot be displayed on the TV monitor connected to S-VIDEO jack.)

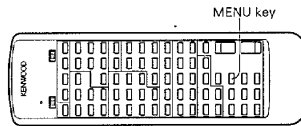

■ Switching the information display

Press the **MENU** key to select the contents to be displayed.



Remote control unit

Each press switches over the screen.

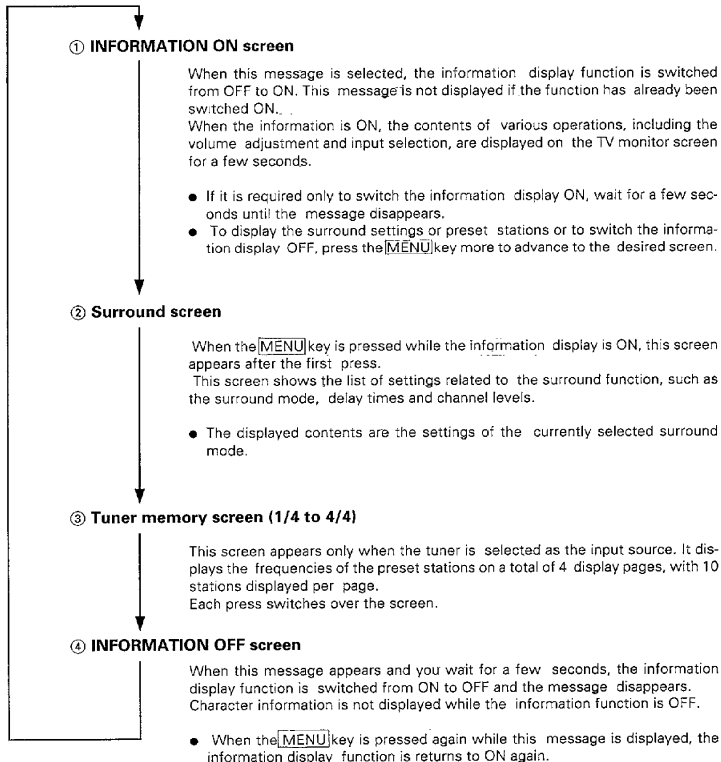

① INFORMATION ON screen

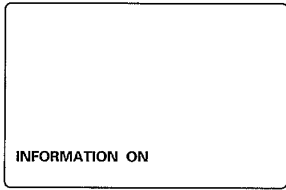

② Surround screen

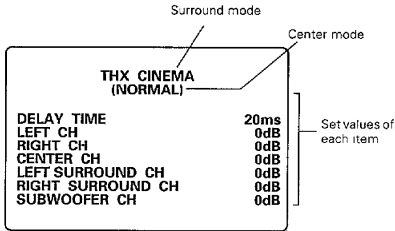

③ Tuner memory screen (1/4 to 4/4)

| NO | BAND | FREQUENCY |
|-----|------|-----------|
| 01. | FM | 88.50MHz |
| 02. | FM | 89.00MHz |
| 03. | FM | 89.50MHz |
| 04. | FM | 90.00MHz |
| 05. | FM | 90.50MHz |
| 06. | FM | 91.00MHz |
| 07. | FM | 91.50MHz |
| 08. | FM | 92.00MHz |
| 09. | FM | 92.50MHz |
| 10. | FM | 93.00MHz |

Preset No.

Broadcasting band

Frequency

The tuner memory information is displayed on 4 pages, with each page displaying information of 10 stations.

④ INFORMATION OFF screen

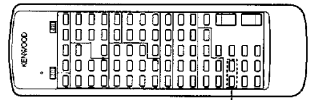
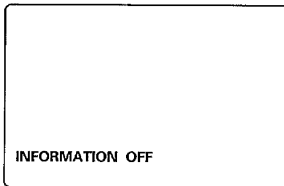

TEST TONE keys

Test tone screen

When the **TEST TONE ON/OFF** key is pressed while the information display is ON to prepare for surround playback, the test tone screen appears on the TV monitor.

Press the **TEST TONE** key while the information display is ON.



Test tone screen
(Example with THX CINEMA mode)

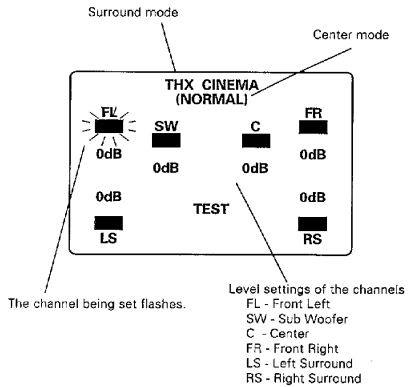

- When the **CHANNEL LEVEL** keys are pressed to adjust the channel level, the value displayed with the flashing channel varies.
- When the **MODE** key is pressed to change the channel, the flashing channel on the screen also changes.
- To end adjustment, press the **TEST TONE ON/OFF** key again. (The adjustment is completed and the screen returns to the normal screen.)

In case of difficulty

What appears to be a malfunction may not always be serious. If your unit should not perform as expected, consult the table below to see if the problem can be corrected before seeking help from your dealer or service representative.

Remote control unit

| Symptom | Cause | Remedy |
|---|---|--|
| Remote control operation is not possible. | <ul style="list-style-type: none"> Batteries are exhausted. The audio cords and the system control cords are not connected properly. The remote control unit is too far away from the main system, controlling angle is too large, or there is an obstacle in between. The source component to be operated does not contain the analog disk, tape(s) or CD. An attempt is made to play a tape which is being recorded in the cassette deck. The AUDIO/AUX switch is not set properly. The LEARN/USE switch is set to "LEARN". The remote control functions have not been programmed properly. You attempted to program a remote control code that cannot be programmed. Another function has already been programmed under the pressed key, or the remote control code has been cleared due to operation mistake. | <ul style="list-style-type: none"> Replace with new batteries. Connect properly referring to "System connections". Operate the remote control unit within the controllable range. Place an analog disk, tape(s) or CD in the source component to be played. Wait until the recording is completed. Set the switch to a proper position. Set the switch to "USE". Program the correctly referring to "Operation of remote control unit". This is not a malfunction. Some of the remote control codes used with other components cannot be programmed under the remote control unit of this unit. Program it again, or erase all of the programmed contents. (refer to pages 18 and 19). |

Amplifier section

| Symptom | Cause | Remedy |
|--|---|---|
| Sound is not output. | <ul style="list-style-type: none"> The speaker cords are disconnected. The volume is set to minimum position. The [MUTE] key is set to ON and the point indicator is blinking. The audio cords or the 25-pin D connector cable are not connected. | <ul style="list-style-type: none"> Connect properly referring to "System connections". Adjust the volume to a proper level. Press the [MUTE] key to OFF. Connect them properly referring to "System connections". |
| Sound is not output from one of the speakers. | <ul style="list-style-type: none"> The BALANCE control is set to an extreme position. An audio cord is not connected. | <ul style="list-style-type: none"> Adjust the Left / Right balance. Connect it properly referring to "System connections". |
| Sound is not output from the Surround speaker and / or center speaker, or their sound is very small. | <ul style="list-style-type: none"> The Surround play mode has not been engaged. The REAR VOL. and / or CENTER VOL. controls are set to the minimum level. | <ul style="list-style-type: none"> Set the Surround mode. Adjust the REAR VOL. and CENTER VOL. controls. |
| A hum noise is generated when the PHONO input selector key is pressed. | <ul style="list-style-type: none"> The audio cord from the turntable is not inserted securely into the PHONO jacks. The turntable is not grounded. | <ul style="list-style-type: none"> Insert the audio cord plugs securely into the PHONO jacks. Connect the grounding wire to the GND terminal on the rear panel. |

Tuner section

| Symptom | Cause | Remedy |
|--|--|--|
| Radio stations cannot be received. | <ul style="list-style-type: none"> No antenna is connected. The broadcast band is not set properly. The frequency of the desired station is not tuned. | <ul style="list-style-type: none"> Connect an antenna. Set the broadcast band properly. Tune the frequency of the desired station. |
| A station which was preset cannot be received by pressing the corresponding numeric key. | <ul style="list-style-type: none"> The preset station belongs to a frequency that cannot be received. The preset memory was cleared because the power cord had been unplugged for a long period of time. | <ul style="list-style-type: none"> Preset a station with a receivable frequency. Preset the station again. |
| Interference. | <ul style="list-style-type: none"> Noise due to ignition noise of an automobile. Noise due to an influence from an electric appliance. Noise due to a nearby TV set. | <ul style="list-style-type: none"> Install the outdoor antenna apart from the road. Turn off the power of the appliance. Install the system more apart from the TV set. |

Notes:

- This system is microprocessor-controlled, so malfunction may occur due to external noise or interference noise. In such a case, unplug the power cord, plug it and turn power on again.
Connect the power cord again and turn the power on while pressing the POWER key.
- Do not use contract cleaners because it could cause a malfunction. Be specially careful against contact cleaners containing oil, for they may deform the plastic components.

For the U.S.A.

FCC WARNING:

This equipment may generate or use radio frequency energy. Changes or modifications to this equipment may cause harmful interference unless the modifications are expressly approved in the instruction manual. The user could lose the authority to operate this equipment if an unauthorized change or modification is made.

NOTE:

This equipment has been tested and found to comply with the limits for a Class B digital device, pursuant to Part 15 of the FCC Rules. These limits are designed to provide reasonable protection against harmful interference in a residential installation. This equipment may cause harmful interference to radio communications, if it is not installed and used in accordance with the instructions. However, there is no guarantee that interference will not occur in a particular installation. If this equipment does cause harmful interference to radio or television reception, which can be determined by turning the equipment off and on, the user is encouraged to try to correct the interference by one or more of the following measures:

- Reorient or relocate the receiving antenna.
- Increase the separation between the equipment and receiver.
- Connect the equipment into an outlet on a circuit different from that to which the receiver is connected.
- Consult the dealer or an experienced radio/TV technician for help.

For CANADA

REGULATION DOC

This digital apparatus does not exceed the CLASS B limits for radio noise emissions from digital apparatus as set out in the radio interference regulations of the Canadian Department of Communications.

SPECIFICATIONS

Caution : Read the pages marked  carefully to ensure safe operation.

AUDIO section

| | |
|---|--------------------------------|
| Total harmonic distortion | 0.002 % (20 Hz- 20 kHz, 1.2 V) |
| | 0.002 % (1 kHz, 1.2 V) |
| Frequency response | |
| LINE (CD, TAPE1, 2, VIDEO1) | 15 Hz- 100 kHz, + 0 dB, - 3 dB |
| PHONO "RIAA" response | 20 Hz - 20 kHz, \pm 0.5 dB |
| Signal to noise ratio (IHF'66) | |
| PHONO (MM) | 78 dB |
| LINE (CD, TAPE 1~2, VIDEO 1~4) | 100 dB |
| Input sensitivity/impedance | |
| PHONO (MM) | 2.5 mV/47 k Ω |
| LINE (CD, TAPE 1~2, VIDEO 1~4) | 200 mV/47 k Ω |
| Tone control | |
| BASS | \pm 8 dB (at 100 Hz) |
| TREBLE | \pm 8 dB (at 10 kHz) |
| Output level/impedance | |
| Front channel preout | 1.2 V/390 Ω |
| Sub woofer, center channel preout | 1.2 V/390 Ω |
| Surround channel preout | 1.2 V/390 Ω |

VIDEO section

| | |
|--|------------------------|
| Television format | NTSC |
| Input level/impedance | |
| VIDEO (Composite) | 1 Vp-p/75 Ω |
| Input (VIDEO 1, 2, 3, 4) | |
| S-VIDEO (Luminance signal) | 1 Vp-p/75 Ω |
| (Chrominance signal) | 0.286 Vp-p/75 Ω |
| Input (VIDEO 1, 2) | |
| Output level/impedance | |
| VIDEO (Composite) | 1 Vp-p/75 Ω |
| output (VIDEO 1, 2, 3, MONITOR OUT 1, 2) | |
| S-VIDEO (Luminance signal) | 1Vp-p/75 Ω |
| (Chrominance signal) | 0.286Vp-p/75 Ω |
| output (VIDEO 1, 2, MONITOR OUT) | |

FM tuner section

| | |
|---|----------------------|
| Tuning frequency range | 87.5 MHz-108 MHz |
| Usable sensitivity (MONO at 75 Ω) | 0.95 μ V/10.8 dB |
| Total harmonic distortion (at 1 kHz) | |
| MONO | 0.1 % (65 dB input) |
| STEREO | 0.2 % (65 dB input) |
| Signal to noise ratio (at 1 kHz) | |
| MONO | 80 dB (65 dB input) |
| STEREO | 74 dB (65 dB input) |
| Stereo separation (at 1 kHz) | |
| 1 kHz | 50 dB |
| Capture ratio (WIDE) | 1.0 dB |
| Selectivity (\pm 400 kHz) | 53 dB |

AM tuner section

| | |
|---|-----------------------------|
| Tuning frequency range | |
| 10 kHz step | 530 kHz - 1,700 kHz |
| Usable sensitivity | 10 μ V/ (400 μ V/m) |
| Signal to noise ratio (at 30% mod. 1mV input) | 50 dB |
| Total harmonic distortion | 0.4 % |

GENERAL

| | |
|-------------------------|------------------|
| Power consumption | 50 W |
| AC outlets | |
| SWITCHED | 3 (940 W max.) |
| Dimensions | |
| W : 440 mm (17-5/16") | |
| H : 161.5 mm (6-3/8") | |
| D : 380 mm (14-15/16") | |
| Weight (Net) | 10.5 kg (23.1lb) |

Note:

KENWOOD follows a policy of continuous advancement in development. For this reason specification may be changed without notice.

Manufactured under license from Dolby Laboratories Licensing Corporation. Additionally licensed under one or more of the following patents: U.S. numbers 3,632,886, 3,746,792 and 3,959,590; Canadian numbers 1,004,603 and 1,037,877. "Dolby" and the double-D symbol  are trademarks of Dolby Laboratories Licensing Corporation.

Produced under approval of Lucas Arts Entertainment Company. Lucas Film THX Audio and HOME THX CINEMA are trademarks of Lucas Arts Entertainment Company. LUCAS FILM is a trademark of Lucas Film, Ltd.

KENWOOD